

CODEC / AUDIO

SHEET 2

+13V0_BATT +9V0 +3V3 +3V0_AN +2V5_CDC +1V0

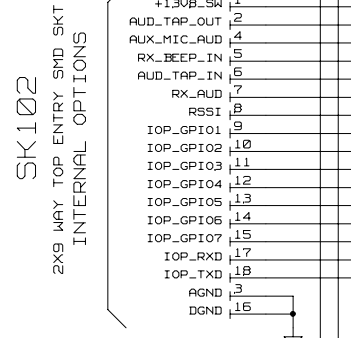
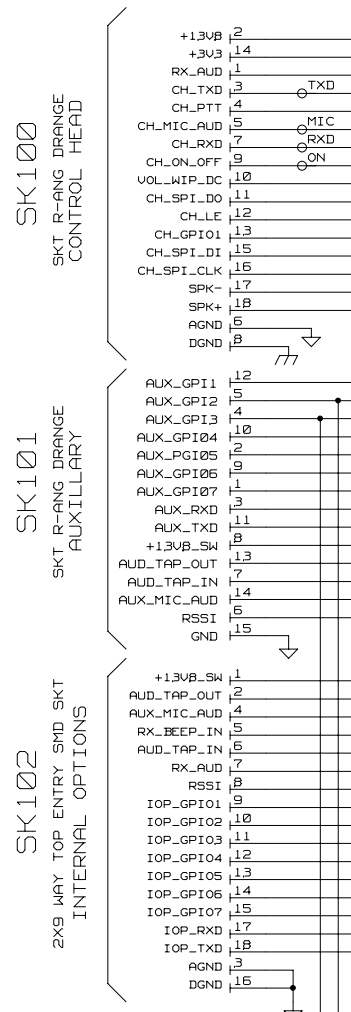
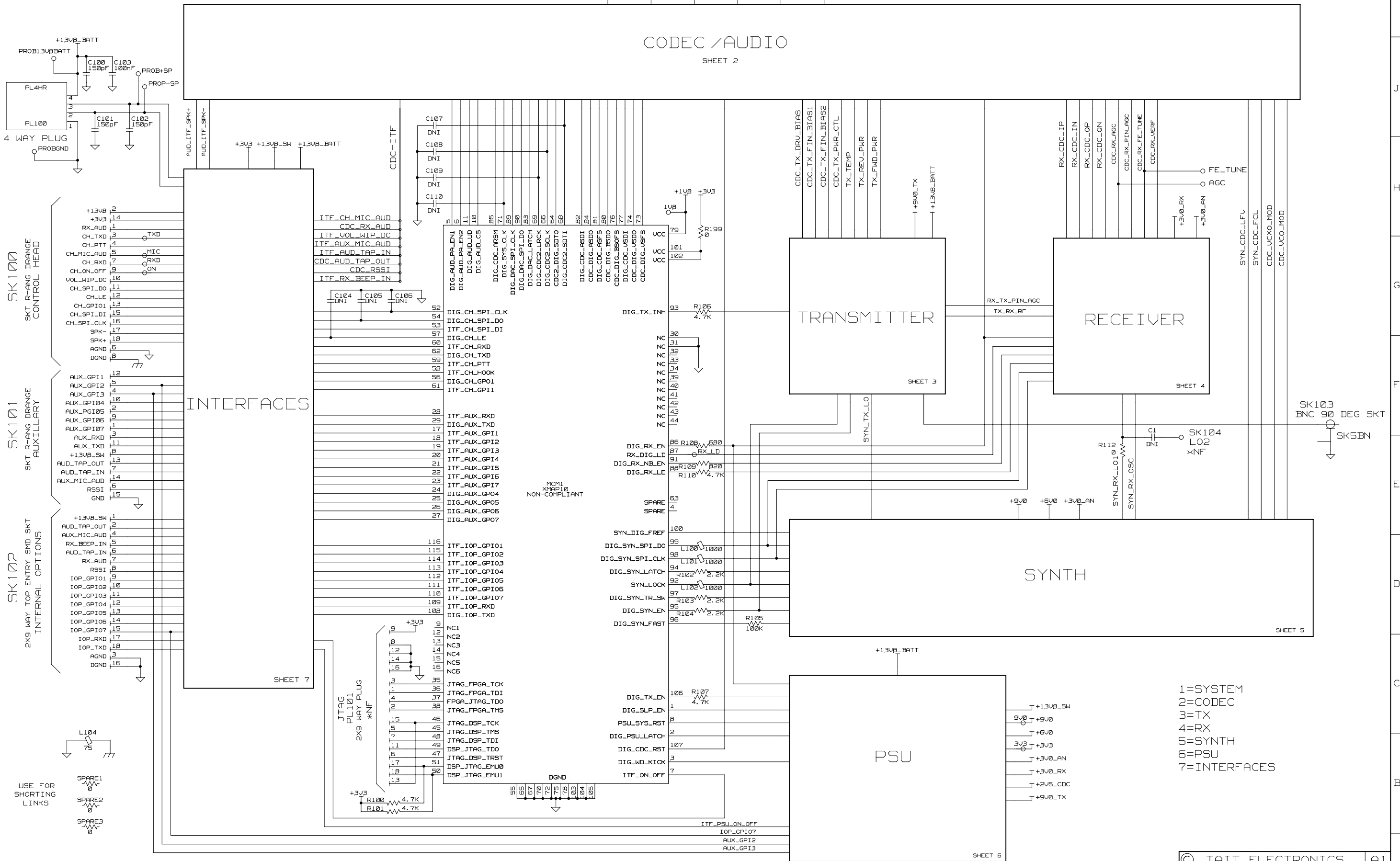

INTERFACES

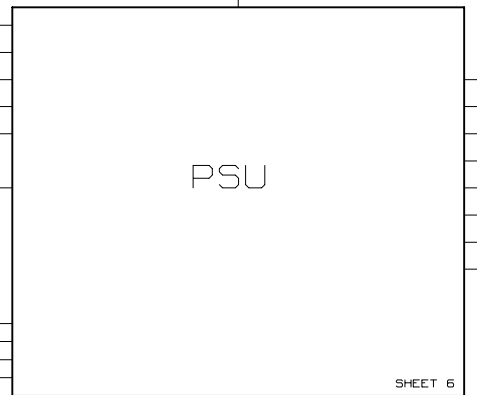
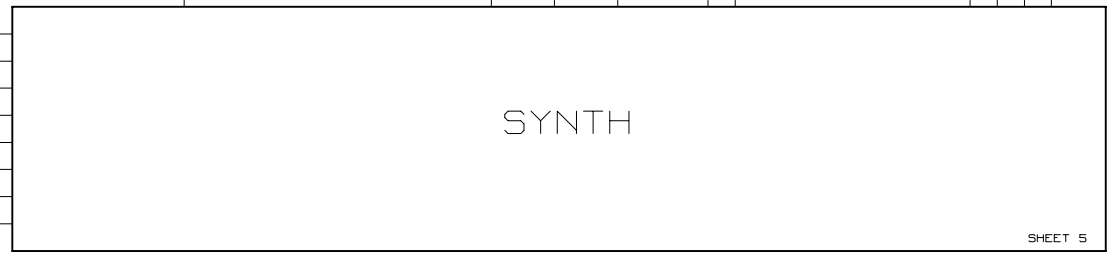
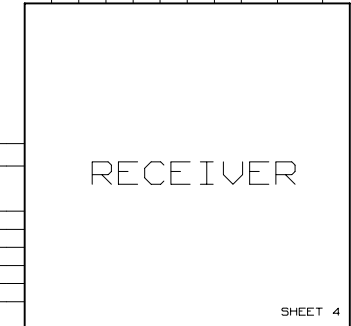
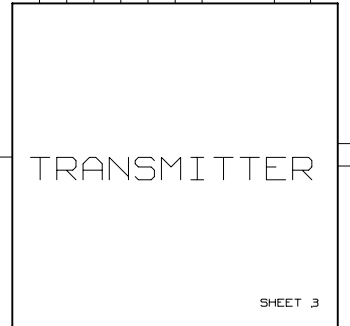
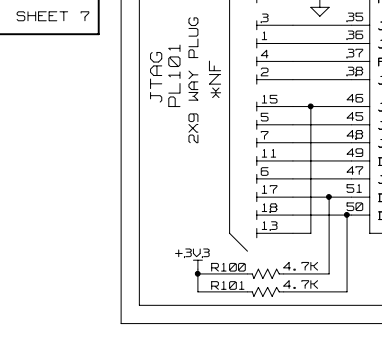

- 1=SYSTEM
- 2=CODEC
- 3=TX
- 4=RX
- 5=SYNTH
- 6=PSU
- 7=INTERFACES

© TAIT ELECTRONICS		A1
TM8000 136-174MHZ SYSTEM		
IPN: 220-01723-01	ISSUE: A	VARIANT NUMBER: ?
FILE DATE: Wed Oct 05 10:19:24 2004		
ENGINEER: Dave Festing	FILE NAME: 220_01723	SHEET NUMBER: 1 OF 7

01A	CLONED FROM 226-00148-02 DC0 01723-001	BRD	CHKD	D.O.	APVD	29-09-04	DATE
REV/ISS	AMENDMENTS	DRAWN	CHKD	D.O.	APVD	DATE	

TOPFID1 FIDUCIAL TOPFID2 FIDUCIAL BOTFID1 FIDUCIAL BOTFID2 FIDUCIAL

DIG_TCAN SHIELD DIG_BCAN SHIELD

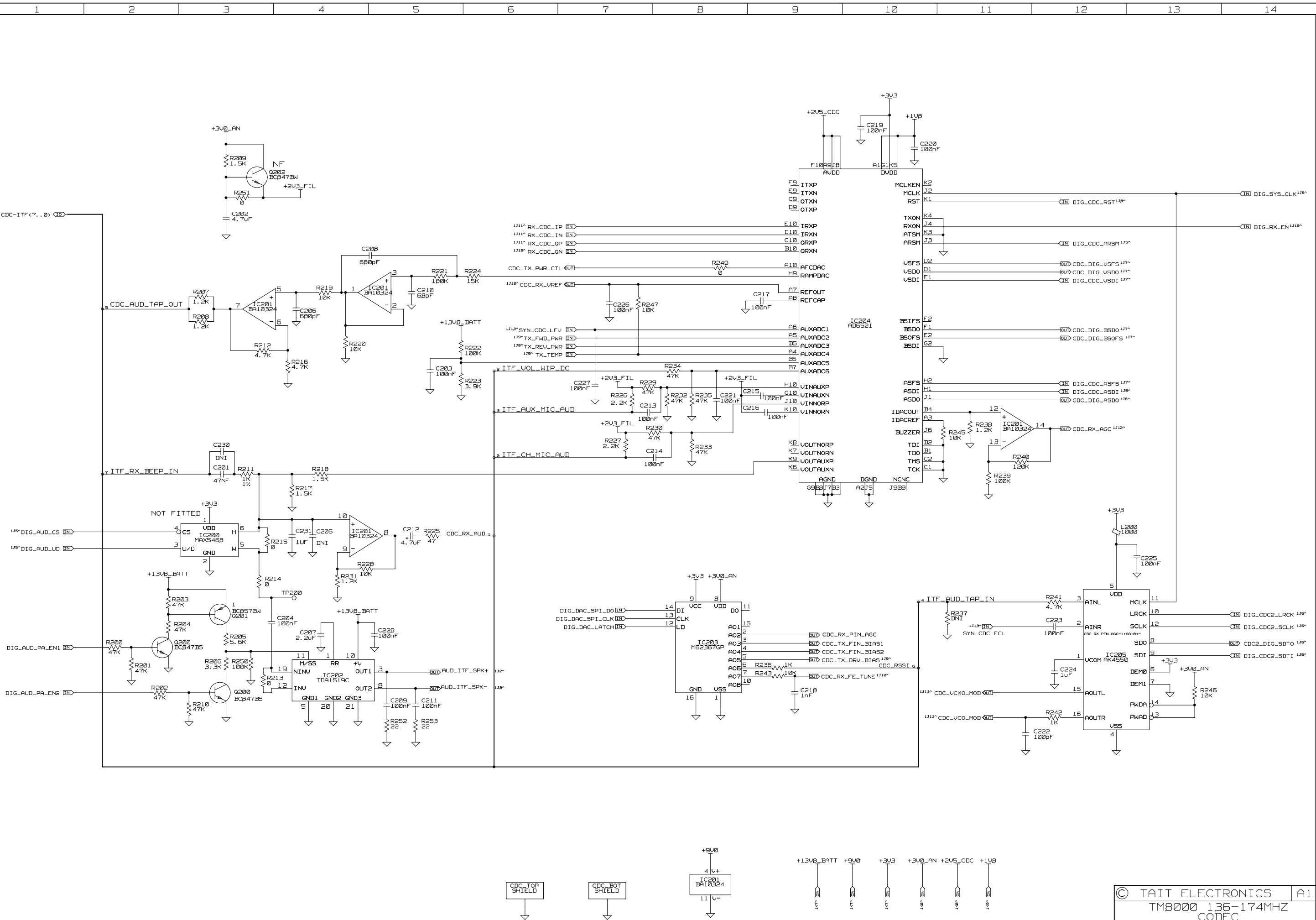

© TAIT ELECTRONICS		A1
TM8000 136-174MHZ CODEC		
IPN: 220-01723-01	ISSUE: A	VARIANT NUMBER: ?
FILE DATE: Tue Oct 05 10:28:42 2004		
ENGINEER: Dave Festing	FILE NAME: 220_01723	SHEET NUMBER: 2 OF 7

REV/ISS	AMENDMENTS	DRAWN	CHKD	D.O.	APVD	DATE
1						
2						
3						
4						
5						
6						
7						
8						
9						
10						
11						
12						
13						
14						

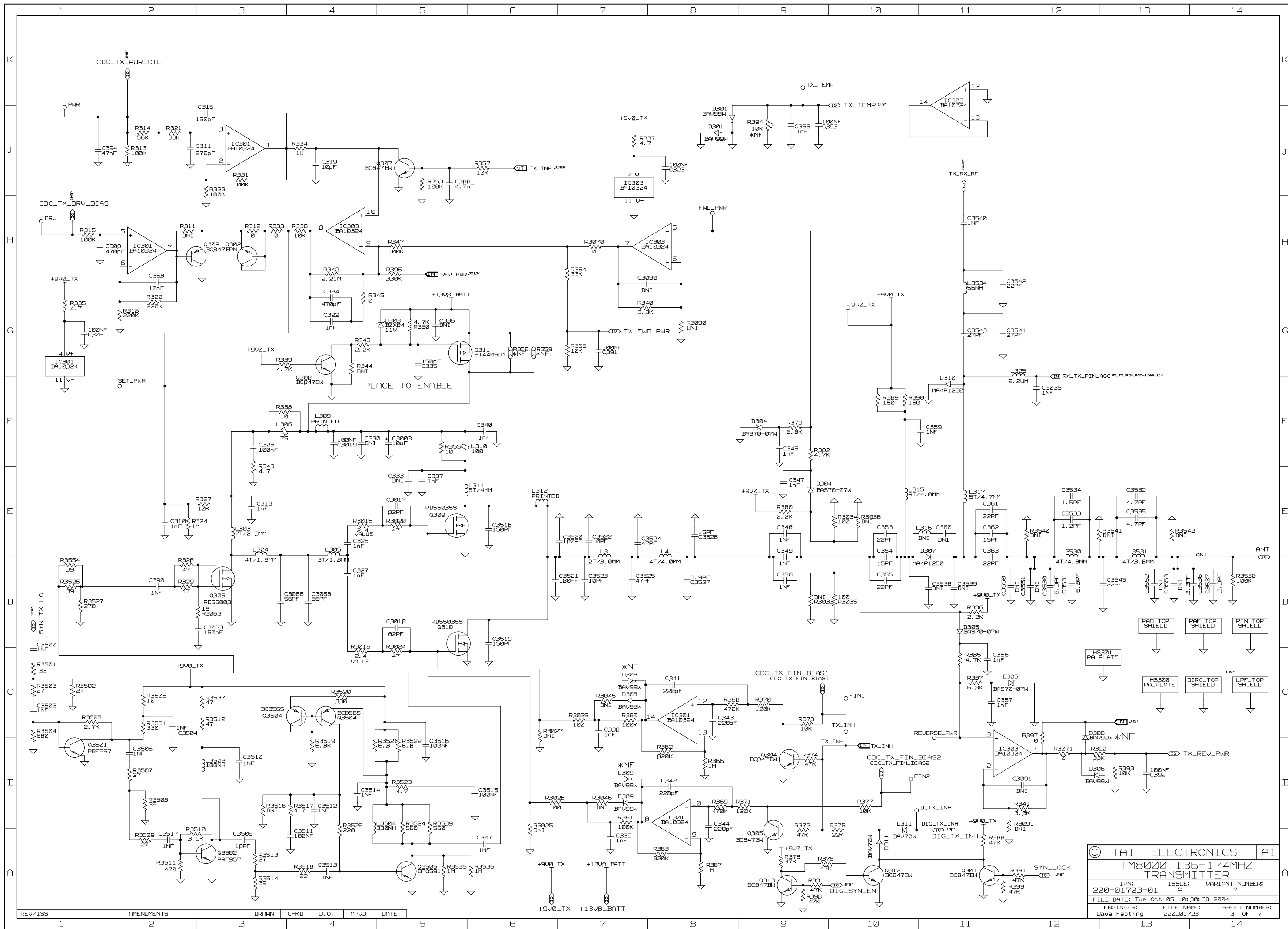

© TAIT ELECTRONICS		A1
TM8000 136-174MHZ TRANSMITTER		
IPN: 220-01723-01	ISSUE: A	VARIANT NUMBER: ?
FILE DATE: Tue Oct 05 10:30:30 2004		
ENGINEER: Dave Festing	FILE NAME: 220_01723	SHEET NUMBER: 3 OF 7

REV/ISS	AMENDMENTS	DRAWN	CHKD	D.O.	APVD	DATE
1						

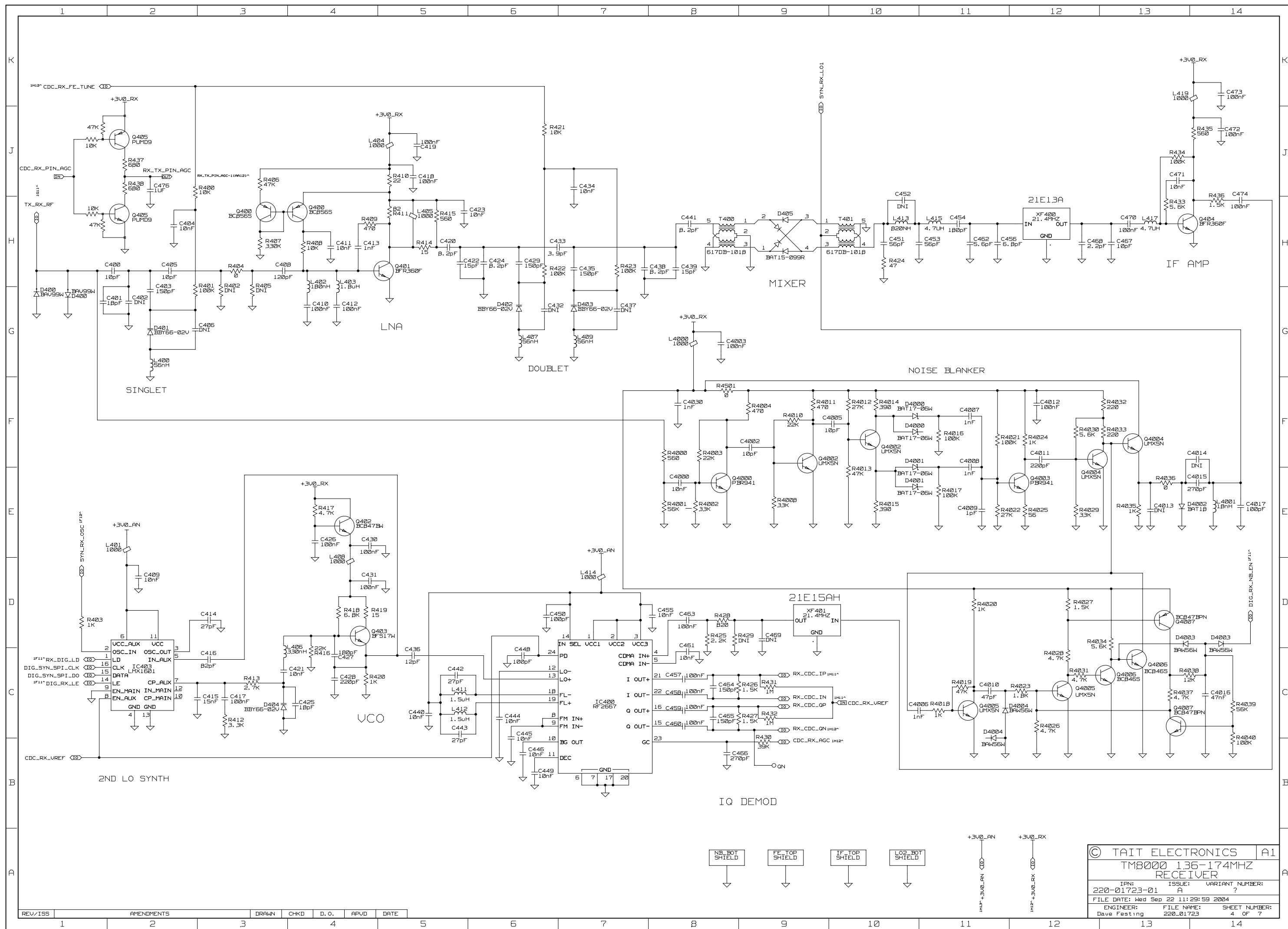

© TAIT ELECTRONICS		A1
TM8000 136-174MHZ RECEIVER		
IPN: 220-01723-01	ISSUE: A	VARIANT NUMBER: ?
FILE DATE: Wed Sep 22 11:29:59 2004		
ENGINEER: Dave Festing	FILE NAME: 220-01723	SHEET NUMBER: 4 OF 7

REV/ISS	AMENDMENTS	DRAWN	CHKD	D. O.	APVD	DATE
1						

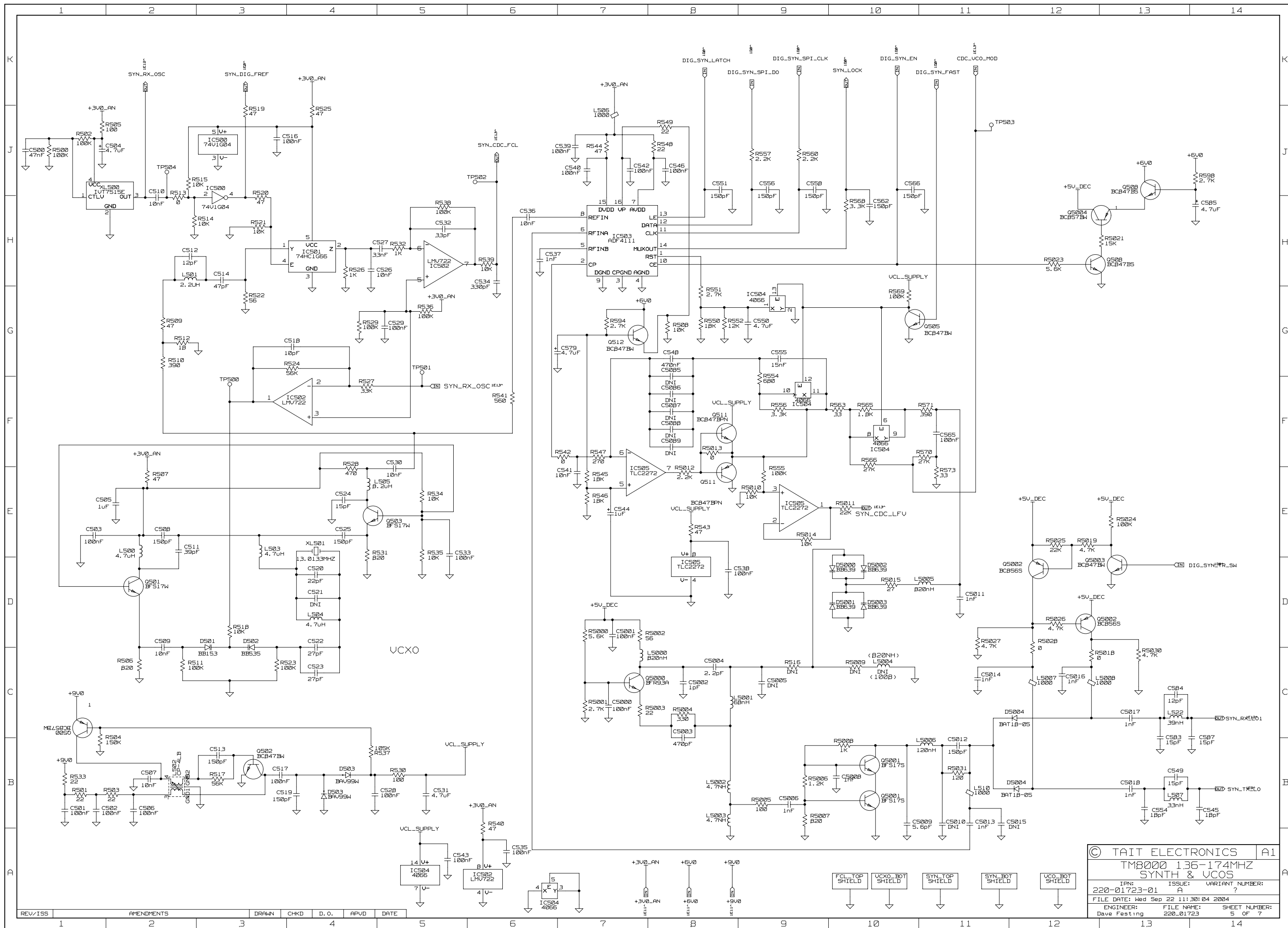

© TAIT ELECTRONICS | A1
 TM801N 1.36-174MHZ
 SYNTH & VCOS
 IPN: 220-01723-01 | ISSUE: A | VARIANT NUMBER: ?
 FILE DATE: Wed Sep 22 11:30:04 2004
 ENGINEER: Dave Festing | FILE NAME: 220_01723 | SHEET NUMBER: 5 OF 7

REV/ISS	AMENDMENTS	DRAWN	CHKD	D.O.	APVD	DATE
1						

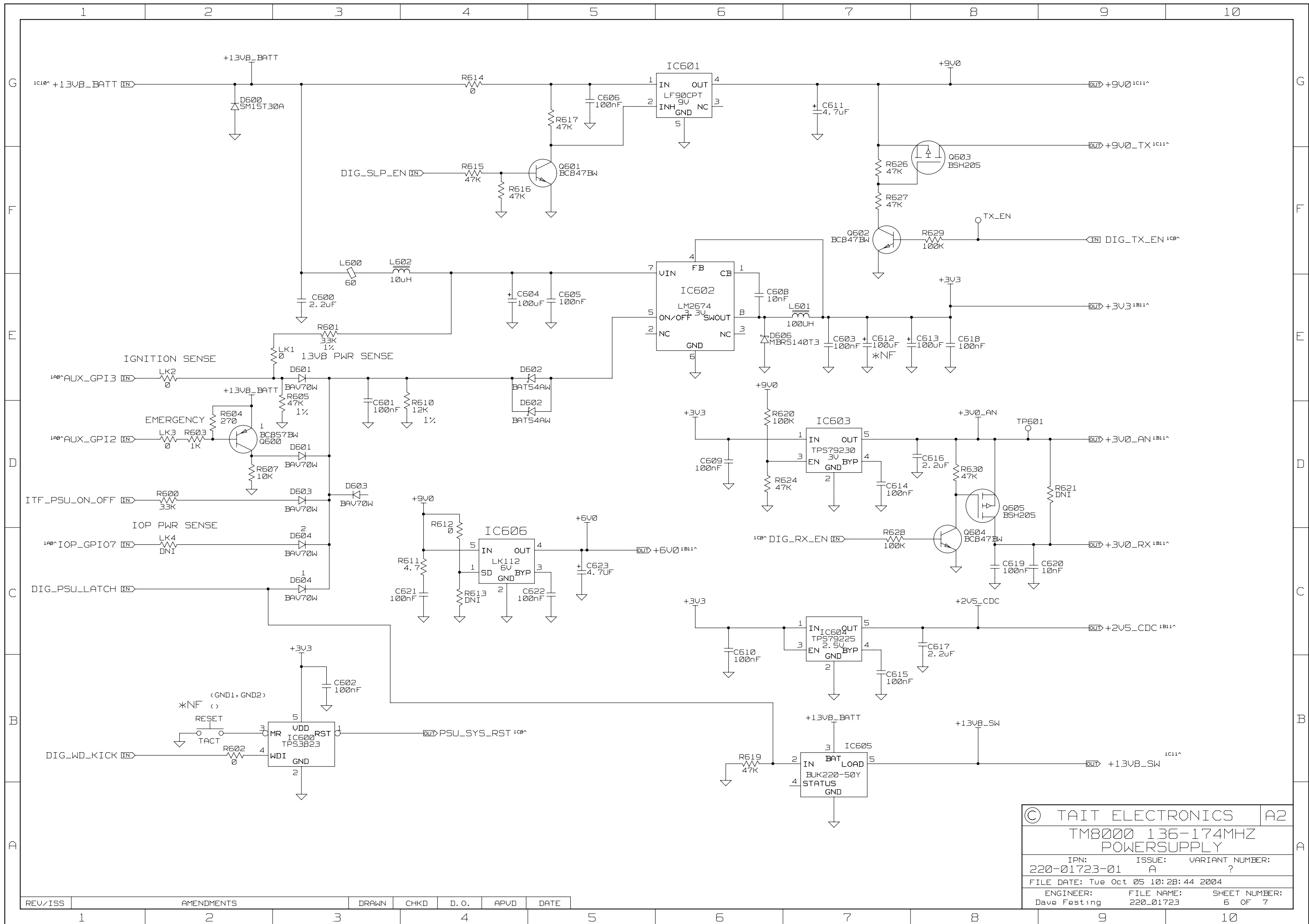

© TAIT ELECTRONICS		A2
TM8000 136-174MHZ POWERSUPPLY		
IPN:	ISSUE:	VARIANT NUMBER:
220-01723-01	A	?
FILE DATE: Tue Oct 05 10:28:44 2004		
ENGINEER:	FILE NAME:	SHEET NUMBER:
Dave Festing	220_01723	6 OF 7

REV/ISS	AMENDMENTS	DRAWN	CHKD	D. O.	APVD	DATE
1						

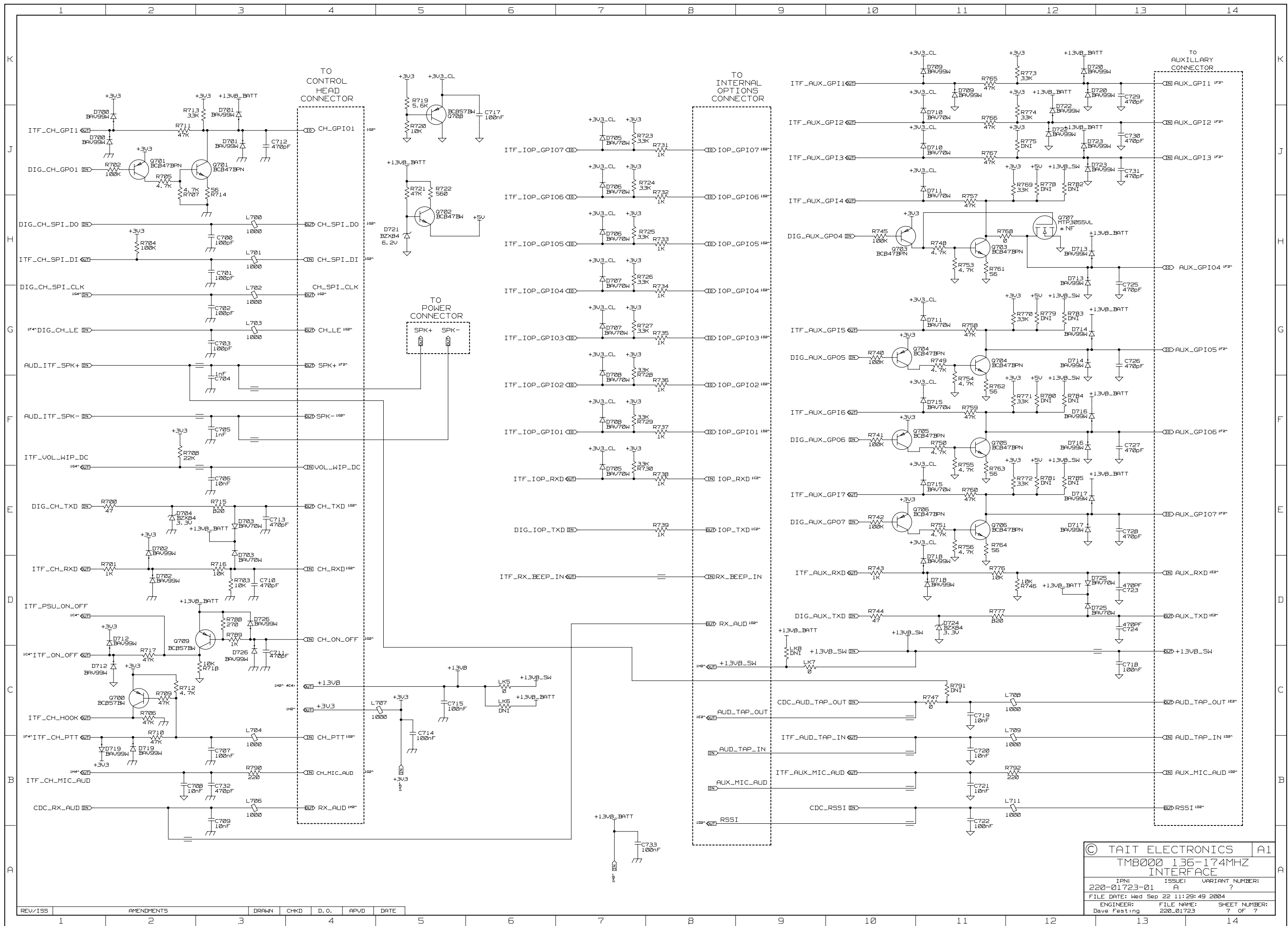

© TAIT ELECTRONICS		A1
TM8000 136-174MHZ INTERFACE		
IPN: 220-01723-01	ISSUE: A	VARIANT NUMBER: ?
FILE DATE: Wed Sep 22 11:29:49 2004		
ENGINEER: Dave Festing	FILE NAME: 220-01723	SHEET NUMBER: 7 OF 7

REV/ISS	AMENDMENTS	DRAWN	CHKD	D.O.	APVD	DATE
1						

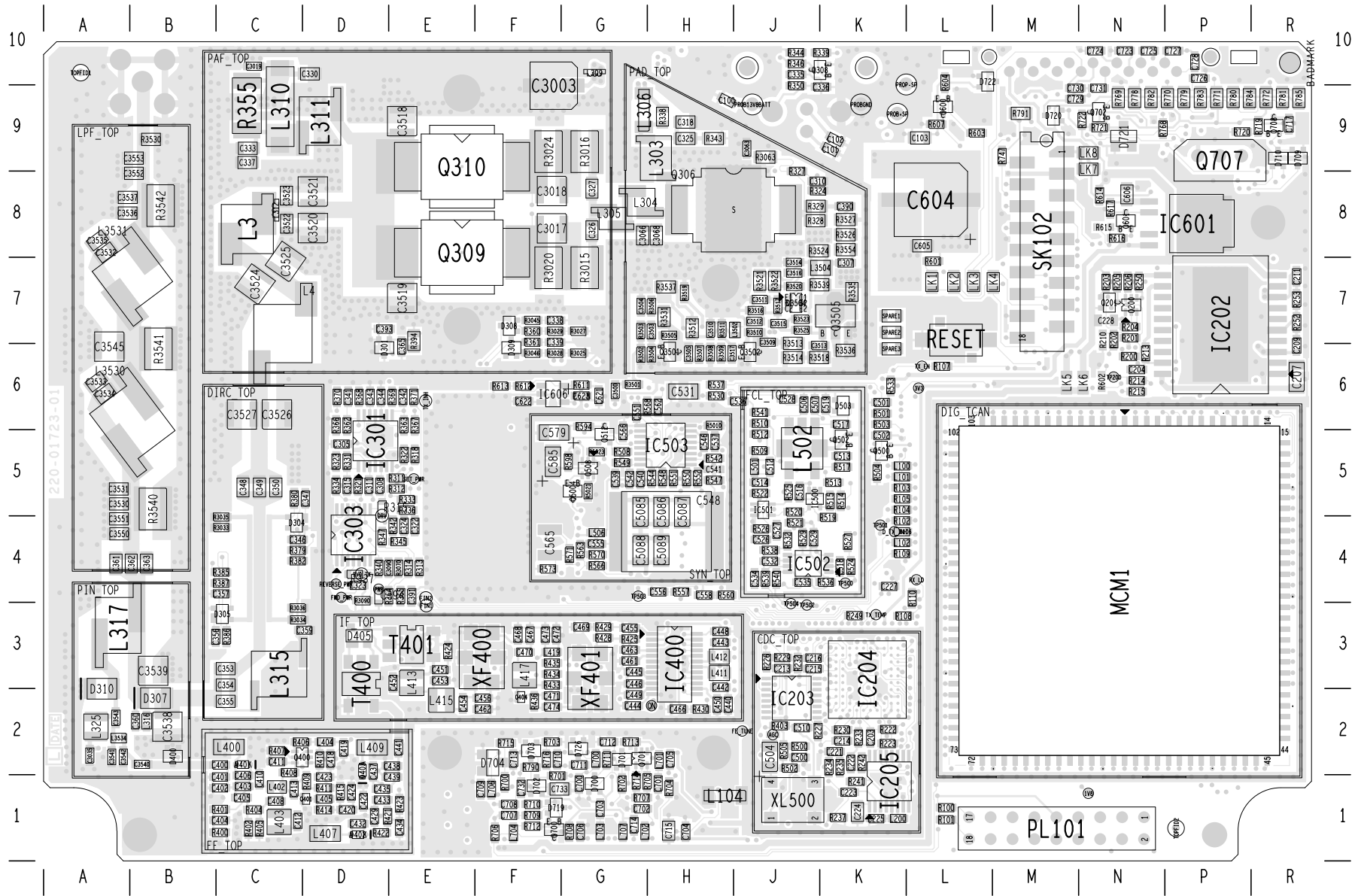

TAIT ELECTRONICS IPN: 220-01723-01 ISS: A DATE: 50ct04 SCALE: NTS
 TMH8000 VHF 136-174MHZ MAIN BOARD LAYOUT-PRIMARY-SIDE

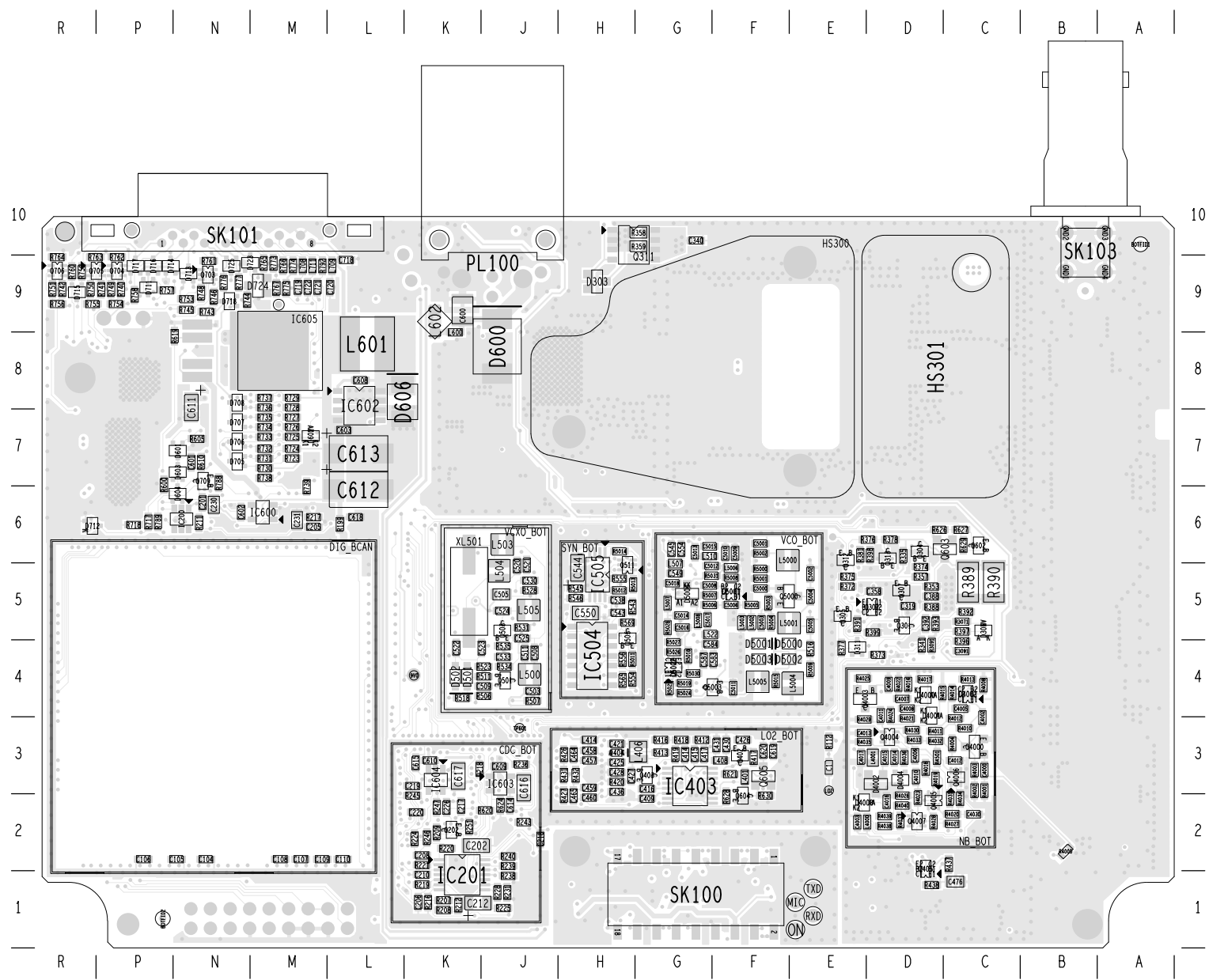

TAIT ELECTRONICS IPN: 220-01723-01 ISS: A DATE: 50ct04 SCALE: NTS
 TMH8000 VHF 136-174MHZ MAIN BOARD LAYOUT-SECONDARY-SIDE